

ALIXA



È tecnologica nei meccanismi e snella nella linea, con un dettaglio di elegante comfort in più: schienale regolabile in altezza con movimento up&down, supporto lombare regolabile, accogliente e personalizzabile con tessuti e colori moda. Disponibile nella versione in rete e tappezzata. Opzionale poggiatesta regolabile.

Featuring hi-tech mechanisms a streamlined design, and enhanced elegance and comfort: height-adjustable backrest with up&down movement, adjustable lumbar support. Comfortable and customisable with a selection of fabrics and trendy colours. Available in a mesh and upholstered version. Optional adjustable headrest.

Ce siège présente des mécanismes technologiques et des lignes épurées, avec un détail de confort élégant en plus : le dossier réglable en hauteur avec mouvement up&down et support lombaire réglable, accueillant et personnalisable avec des tissus et des couleurs à la mode. Disponible en version résille et rembourrée. Repose-tête réglable en option.

Se trata de una silla tecnológica en sus mecanismos y esbelta en su diseño, con un detalle extra de elegante confort: un respaldo ajustable en altura con movimiento up&down, apoyo lumbar ajustable, cómodo y personalizable con tejidos y colores de moda. Disponible en versión de malla y tapizada. Reposacabeza ajustable opcional.



ALIXA

Un comfort da primato in ogni dettaglio
Unrivalled comfort in every detail
Un confort de première classe dans les moindres détails
Confort de primera clase en cada detalle



ALIXA

Alixà è la sedia LT Form che per prima ha raggiunto tutti gli standard dimensionali e ergonomici previsti dalle normative vigenti in fatto di lavoro a videoterminale.

Lo **schienale** dalle linee nette e classiche combina ergonomia e stile per un comfort ottimale, dotato di un lombare che garantisce la naturale curva della colonna vertebrale riducendo danni muscoloscheletrici a lungo termine.

L'ampia regolabilità dei **braccioli** 360° con top soft touch consentono la riduzione della tensione muscolare di spalle e collo.

Il **meccanismo** con quattro posizioni di blocco e traslatore garantisce tutte le regolazioni fondamentali previste dalle vigenti norme in modo da evitare movimenti innaturali e quindi eventuali sforzi muscolari. Dall'antishock sull'oscillazione alle 4 posizioni di blocco (di cui una in posizione lavorativa), per finire con la **traslazione del sedile** tutte concorrono al benessere dell'utente finale.

Il **sedile** dalle dimensioni generose ma mai eccessive, garantisce il giusto comfort durante le lunghe sessioni di lavoro.

Alixà was the first LT Form chair to meet all the dimensional and ergonomic standards required by current regulations for working with visual display units.

The **backrest** teams clean, classic lines with ergonomics and style for optimal comfort. Equipped with a lumbar support that ensures the natural curvature of the spine, thus reducing the risk of long-term musculoskeletal damage.

The great range of adjustment of the **360° armrests** with soft touch top reduce muscle tension in the shoulders and neck.

The **mechanism** with four locking positions and seat slider guarantees all essential adjustments required by current regulations to avoid unnatural movement and therefore over-exertion of muscles. The anti-shock oscillation, 4 locking positions (one of which in working position), and the **seat slider** all work together to ensure the well-being of the end user.

The seat's **sizing is generous without being excessive** to guarantee just the right degree of comfort during long work sessions.

Alixà est la chaise LT Form qui a été la première à obtenir toutes les normes dimensionnelles et ergonomiques requises par les réglementations actuelles pour le travail avec des terminaux vidéo.

Le **dossier** aux lignes épurées et classiques allie ergonomie et style pour un confort optimal, avec un support lombaire qui assure la courbe naturelle de la colonne vertébrale, tout en réduisant les problèmes musculo-squelettiques à long terme.

Les **accoudoirs** à 360°, largement réglables et dotés d'un dessus soft touch réduisent les tensions musculaires au niveau des épaules et du cou.

Le **mécanisme** à quatre positions et la glissière garantissent tous les réglages fondamentaux requis par les normes en vigueur, afin d'éviter les mouvements non naturels et donc les éventuelles tensions musculaires. Inclinaison antichoc, oscillation à 4 positions (dont une en position de travail) et enfin la **translation d'assise**: toutes contribuent au bien-être de l'utilisateur final.

L'**assise**, de taille généreuse mais jamais surdimensionnée, garantit un confort optimal pendant les longues sessions de travail.

Alixà es la silla de LT Form que ha sido la primera en cumplir con todas las normas dimensionales y ergonómicas exigidas por la normativa vigente para trabajar en videoterminal.

El **respaldo**, de líneas limpias y clásicas, combina la ergonomía y el estilo para un confort óptimo, con un apoyo lumbar que garantiza la curva natural de la columna vertebral, reduciendo los daños musculoesqueléticos a largo plazo.

Los **reposabrazos** ajustables en 360° con cubierta suave reducen la tensión muscular en los hombros y el cuello.

El **mecanismo** con cuatro posiciones de bloqueo y deslizador garantiza todos los ajustes básicos requeridos por las normas vigentes para evitar movimientos antinaturales y, por tanto, posibles tensiones musculares. Desde la función antichoque en la oscilación hasta las 4 posiciones de bloqueo (una de ellas en posición de trabajo), pasando por la **deslizamiento del asiento** todo contribuye al bienestar del usuario final.

El **asiento**, de generosas dimensiones pero no desmesuradas, garantiza la comodidad adecuada durante las largas jornadas de trabajo.

01. Poggiatesta imbottito regolabile in altezza.
02. Schienale in rete regolabile in altezza tramite pratico sistema up & down con lama in Nylon.
03. Lombare regolabile in altezza.
04. Braccioli regolabili in altezza, profondità tramite slide del pad avanti e dietro, più rotazione di 360° del top.
05. Sedile imbottito dalle dimensioni adeguate affinché altezza, larghezza e profondità (regolabile come da norma) concorrano a garantire la corretta postura dell'utilizzatore durante le sessioni di lavoro.
06. Meccanismo sincronizzato con quattro posizioni di blocco e sistema antishock.

01. Height-adjustable upholstered headrest.
02. Mesh backrest with height adjustment by means of a practical up&down system with Nylon back bar.
03. Height-adjustable lumbar support.
04. Armrests adjustable in height and depth by sliding the seat pad back and forth, plus 360° rotation of the top.
05. Upholstered seat with adequate proportions ensure height, width and depth (adjustable as per standard) contribute to guaranteeing the correct posture of the user during work sessions.
06. Synchronised mechanism with four locking positions and anti-shock system.

01. Repose-tête rembourré réglable en hauteur.
02. Dossier en résille, réglable en hauteur par système up & down pratique avec lame en nylon.
03. Support lombaire réglable en hauteur.
04. Accoudoirs réglables en hauteur et en profondeur par le biais d'un dessus coulissant vers l'avant et vers l'arrière, ainsi qu'une rotation à 360°.
05. Siège rembourré, dimensionné de manière à ce que sa hauteur, sa largeur et sa profondeur (réglable conformément à la norme) contribuent à garantir une posture correcte de l'utilisateur pendant les sessions de travail.
06. Mécanisme synchronisé à quatre positions et système antichoc.

01. Reposacabeza acolchado ajustable en altura.
02. Respaldo de malla de altura ajustable mediante práctico sistema up&down con hoja de nylon.
03. Apoyo lumbar de altura ajustable.
04. Reposabrazos ajustables en altura y profundidad mediante el deslizamiento hacia delante y hacia atrás y la rotación de 360° del top.
05. Asiento acolchado debidamente dimensionado para que su altura, anchura y profundidad (ajustables según la norma) contribuyan a garantizar la postura correcta del usuario durante las jornadas de trabajo.
06. Mecanismo synchro con cuatro posiciones de bloqueo y sistema antichoque.

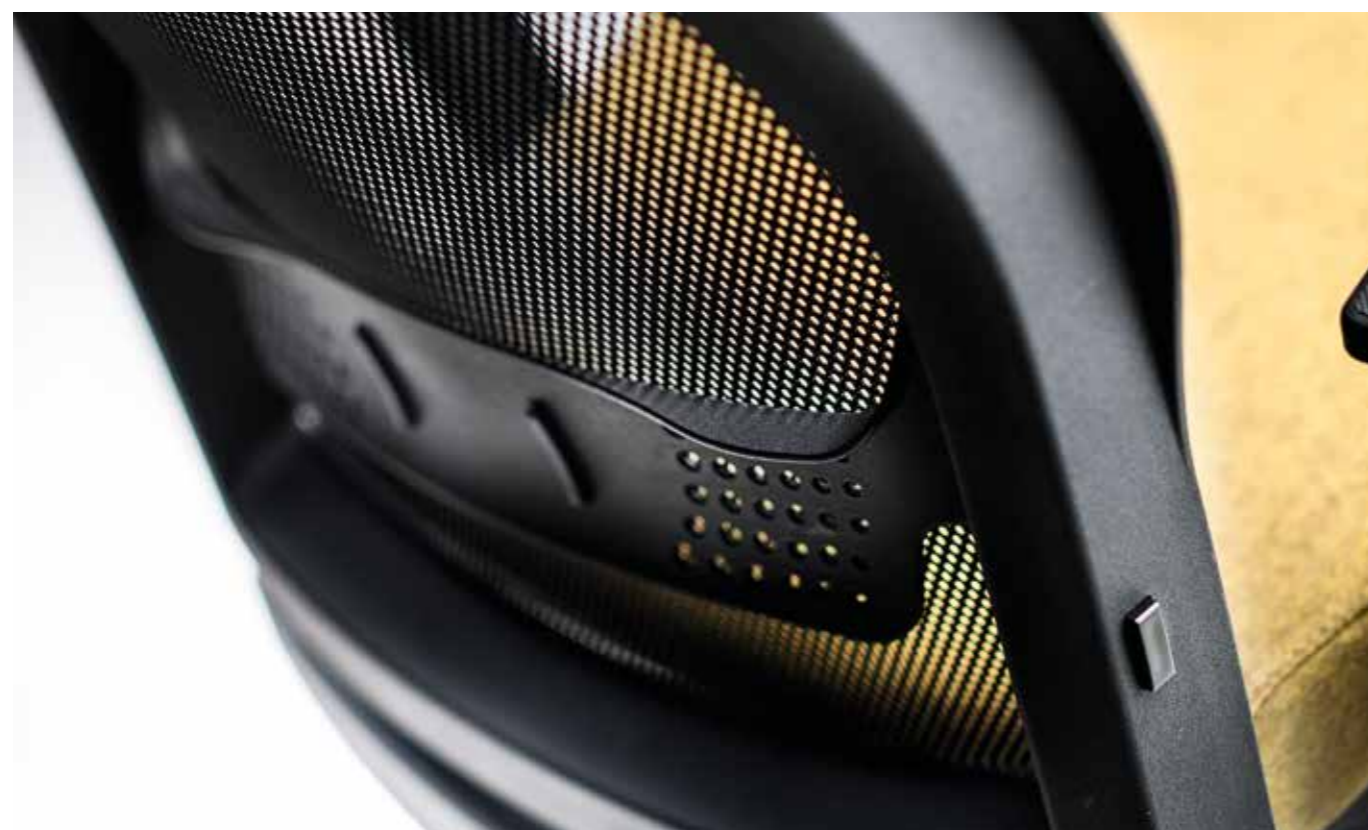

ALIXA

Il sedile in rete: unico, innovativo e indispensabile
 Mesh seat: unique, innovative and indispensable
 L'assise en résille : unique, novatrice et indispensable
 El asiento de malla: único, innovador e indispensable

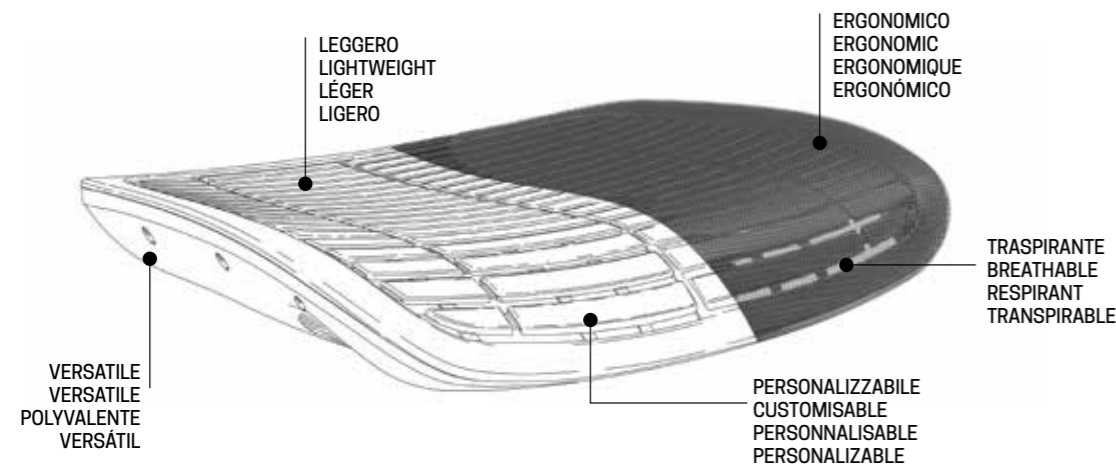

La seduta Alixa è disponibile anche con l'innovativo sedile in rete: il suo profilo sottile ed elegante è in grado di alleggerire la linea della sedia e le sue dimensioni generose lo rendono confortevole. Il pannello traforato, rivestito dalla rete, perfettamente traspirante, è frutto di uno studio approfondito su elasticità ed ergonomia e dona alla seduta un aspetto di elegante trasparenza. Tutto ciò permette la flessione perfetta, ai fini del conseguimento della corretta postura dell'utente. È possibile scegliere il colore della rete, coordinato allo schienale o a contrasto, per un effetto bicolore.

The Alixa chair is also available with the innovative mesh seat: its slim, elegant profile lightens the lines of the chair while generous proportions ensure outstanding comfort. The mesh-covered perforated seat pad provides excellent breathability. It's the culmination of in-depth research into elasticity and ergonomics and gives the seat an elegant see-through appearance. The result is perfect flex to ensure the correct posture of the user. Possibility to choose a mesh colour which matches the backrest or a contrast colour to create a two-tone effect.

Le siège Alixa est également disponible avec l'innovative assise en résille : son profil fin et élégant allège la ligne de la chaise et ses dimensions généreuses la rendent confortable. Le panneau ajouré, recouvert de résille parfaitement respirante, est le résultat d'une étude approfondie de l'élasticité et de l'ergonomie et donne à cette assise un aspect de transparence élégante. Tout cela permet une flexion parfaite, afin d'obtenir la posture correcte de l'utilisateur. Il est possible de choisir la couleur de la résille pour l'assortir au dossier ou la contraster pour un effet bicolore.

La silla Alixa también está disponible con el innovador asiento de malla: su perfil delgado y elegante aligera la línea de la silla y sus generosas dimensiones la hacen cómoda. El panel perforado, cubierto por la malla, que es perfectamente transpirable, es el resultado de un profundo estudio de elasticidad y ergonomía y da a la silla una apariencia de elegante transparencia. Todo ello permite la flexión perfecta, para conseguir la postura correcta del usuario. Es posible elegir el color de la malla, a juego o en contraste, para conseguir un efecto bicolor.

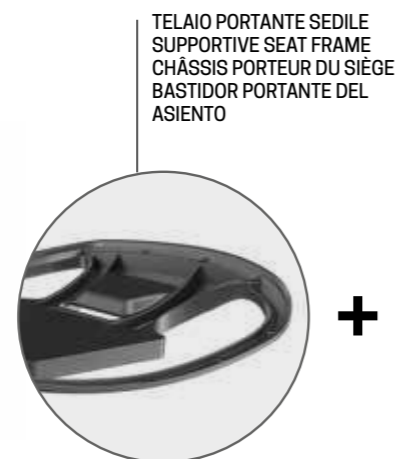

+

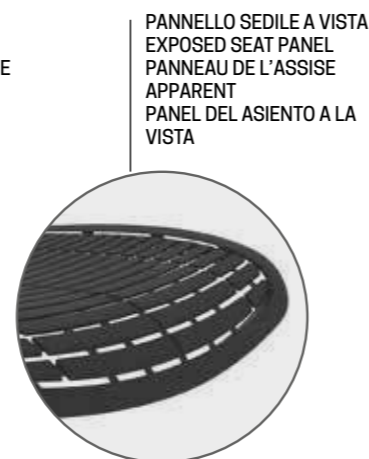

- | | | | |
|---|--|---|---|
| <p>01. Schienale in rete regolabile in altezza tramite pratico sistema up & down, con lama in nylon.</p> <p>02. Lombare regolabile in altezza per un maggiore comfort realizzato al 100% da materiale riciclato.</p> <p>03. Braccioli regolabili in altezza, profondità tramite slide del pad avanti e dietro.</p> <p>04. Sedile in rete dal profilo sottile ed elegante, in grado di alleggerire la linea della sedia. Dimensioni generose che lo rendono confortevole. Traspirante grazie al pannello traforato, raggiunge la flessione perfetta per la corretta postura dell'utente.</p> <p>05. Meccanismo sincronizzato con cinque posizioni di blocco, traslatore e sistema antishock.</p> | <p>01. Mesh backrest adjustable in height by means of a practical up&down system, with nylon back bar.</p> <p>02. Height adjustable lumbar region for added comfort made from 100% recycled material.</p> <p>03. Armrests adjustable in height and depth by sliding the seat pad back and forth.</p> <p>04. Mesh seat with a slimline, elegant profile, which lends a lighter look to the chair. Generous proportions ensure superb comfort. The perforated seat pad ensures excellent breathability, delivering perfect flex to ensure the correct posture of the user.</p> <p>05. Synchronised mechanism with five locking positions, seat slider and anti-shock system.</p> | <p>01. Dossier en résille, réglable en hauteur par système up/down, lame en nylon.</p> <p>02. Support lombaire réglable en hauteur pour un meilleur confort, réalisé avec 100 % de matériau recyclé.</p> <p>03. Accoudoirs réglables en hauteur et en profondeur par le biais d'un dessus coulissant vers l'avant et vers l'arrière.</p> <p>04. Assise en résille avec un profil fin et élégant qui allège la ligne de la chaise. Des dimensions généreuses qui la rendent confortable. Respirante grâce au panneau ajouré, elle offre une flexion parfaite afin d'obtenir une posture correcte de l'utilisateur.</p> <p>05. Mécanisme synchronisé à cinq positions, glissière et système antichoc.</p> | <p>01. Respaldo de malla de altura ajustable mediante práctico sistema up&down con hoja de nylon.</p> <p>02. Apoyo lumbar ajustable en altura para un mayor confort, fabricado con material 100% reciclado.</p> <p>03. Reposabrazos ajustables en altura, profundidad mediante el deslizamiento del top hacia delante y hacia atrás.</p> <p>04. El asiento de malla con un perfil delgado y elegante aligera la línea de la silla. Sus dimensiones generosas lo vuelven cómodo. Transpirable gracias al panel perforado, alcanza la flexión perfecta para la postura correcta del usuario.</p> <p>05. Mecanismo synchro con cinco posiciones de bloqueo, deslizador y sistema antichoque.</p> |
|---|--|---|---|



CATEGORIA/CATEGORY B
TESSUTO POLIPROPILENE
IGNIFUGO

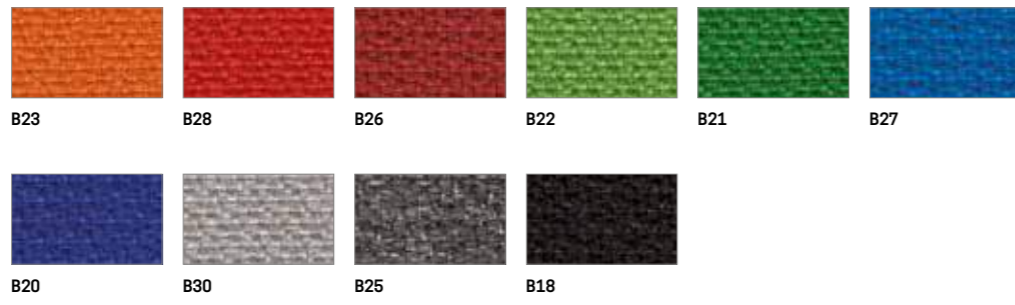

CATEGORIA/CATEGORY B
COVENTRY

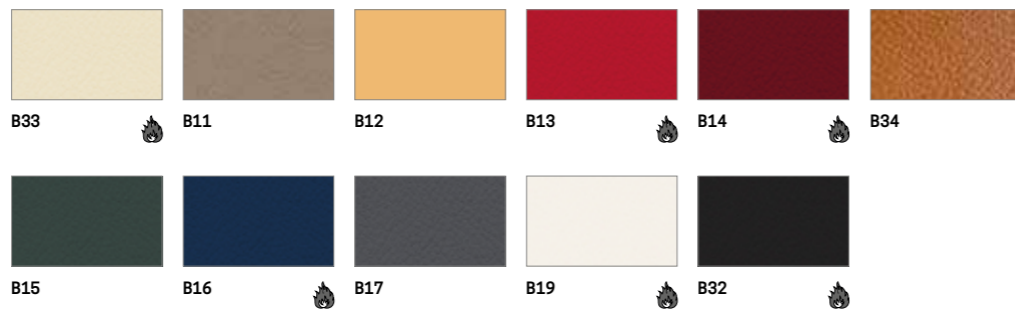

CATEGORIA/CATEGORY C
CREPE MIRAGE



CATEGORIA/CATEGORY C
HAPPY



CATEGORIA/CATEGORY E
TREVU

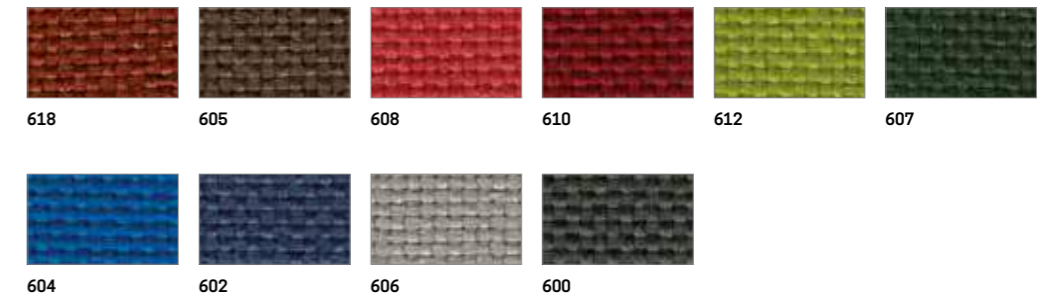

CATEGORIA/CATEGORY E
JET

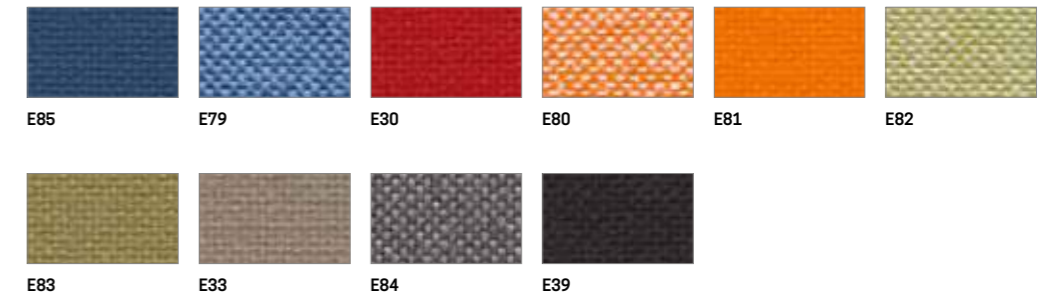

CATEGORIA/CATEGORY E
FENICE



CATEGORIA/CATEGORY E
LOVE



CATEGORIA/CATEGORY E
ALL ROAD

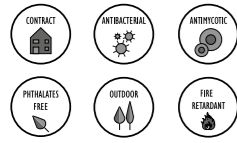

CATEGORIA/CATEGORY G
DISCO COEX BY
CHIOCCARELLO

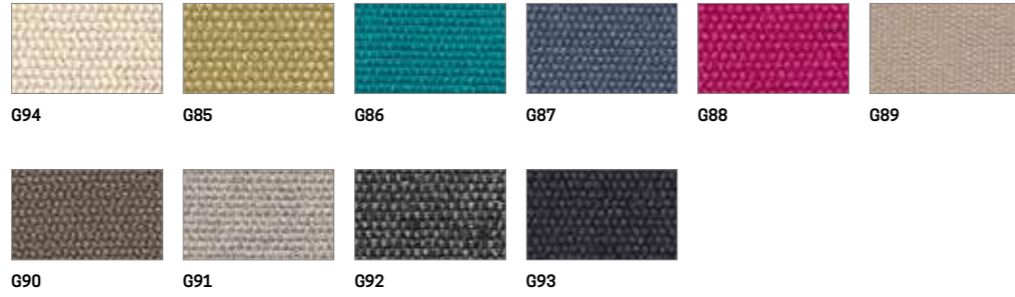

CATEGORIA/CATEGORY G
CLASS BY FIDIVI

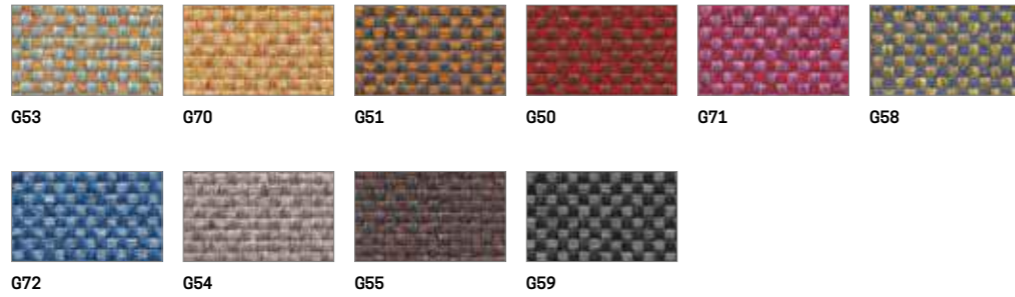
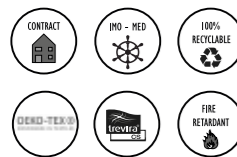

CATEGORIA/CATEGORY G
MEDLEY BY GABRIEL



CATEGORIA/CATEGORY L
CAPTURE BY GABRIEL



CATEGORIA/CATEGORY P
POLO



RETE/NET
I



RETE/NET
P

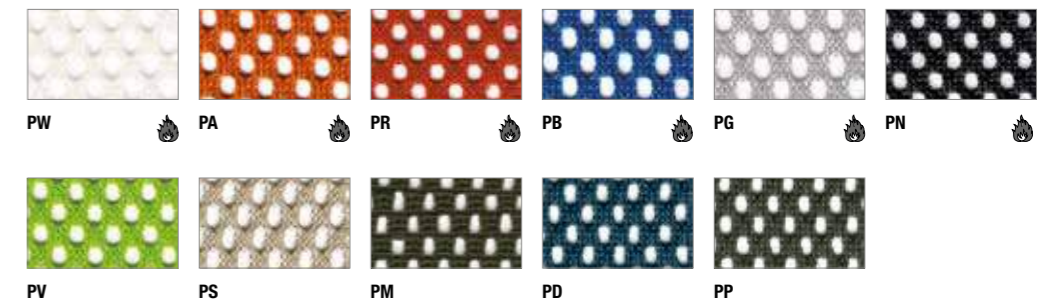

CATEGORIA/CATEGORY
M

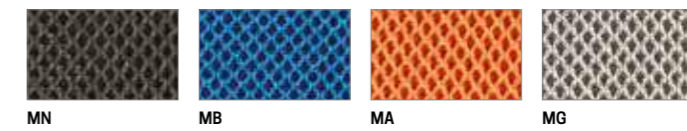

RETE/NET
ACCENTO

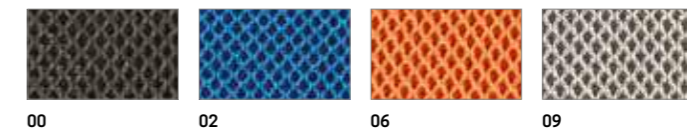

RETE/NET
NIMBUS

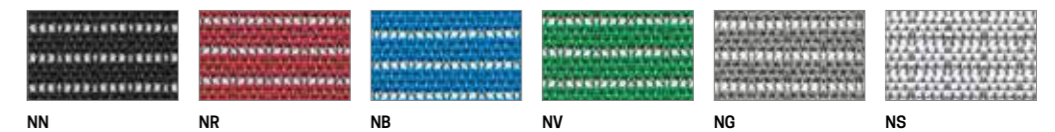

RETE/NET
ARGENTA

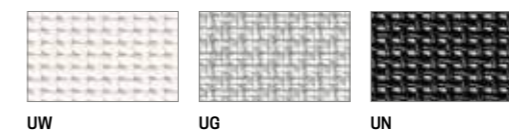



DIMENSIONI / SIZE

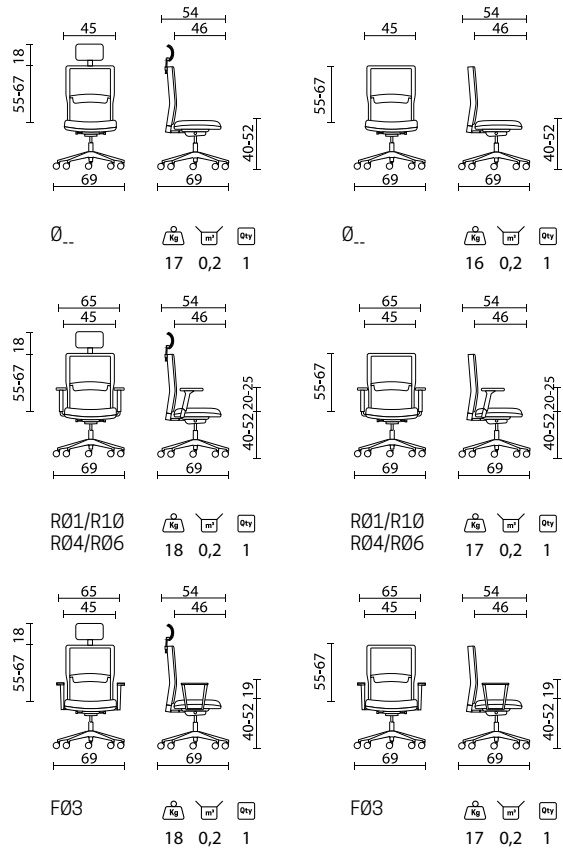

CERTIFICAZIONI / CERTIFICATIONS



SEDIA OPERATIVA

POGGIATESTA

Allo schienale è applicabile un poggiatesta in nylon regolabile in altezza con imbottitura in poliuretano espanso stampato a freddo.

SCHIENALE

Telaio portante in nylon con cornice di supporto rete in polipropilene. Schienale regolabile in altezza tramite sistema up/down e supporto lombare regolabile in altezza, lama portante in nylon.

SEDILE

Imbottito con poliuretano "flessibile" stampato a freddo, autoestingente, privo di CFC/HCFC, con ODP=0 (Ozone Depletion Potential), non contribuisce alla riduzione dello strato di ozono atmosferico. Struttura interna in materiale plastico PP da materiale riciclato 100%, carter esterno in materiale plastico polipropilene (PP).

BRACCIOLI

Disponibile nella tipologia fisso o regolabili 1D: in altezza, 3D altezza, rotazione e traslazione o regolabili 4D: altezza, larghezza, rotazione e traslazione in avanti del top soft touch TPU. Disponibile inoltre bracciolo con regolazione 360° e top soft touch in TPU.

MECCANISMI

Disponibili tre diverse tipologie di meccanismo: Synchron 4 blocchi con o senza traslatore e synchron 5 blocchi con traslatore e variatore d'assetto.

COLONNA A GAS

Colonna a gas in acciaio che permette la regolazione in altezza del sedile.

BASE

Tipologia a cinque razze piramidale in nylon (PA) con apposite nervature di rinforzo, diametro 690 mm o in alluminio lucido diametro 690 mm.

RUOTE

Libere da diametro 55 mm e autofrenanti cromate e non diametro 65 mm. (ognuna dedicata alla base adatta).

TESSUTI E RETI

Disponibili in diverse tipologie e colorazioni presenti nelle cartelle rivestimenti LT Form.

OPERATIVE CHAIR

HEADREST

Backrest can be fitted with a height-adjustable nylon headrest with cold-moulded polyurethane foam upholstery.

BACKREST

Supporting frame in nylon with mesh support frame in polypropylene. Height-adjustable backrest with up/down system and height-adjustable lumbar support, nylon back bar.

SEAT

Upholstered with "flexible" cold-moulded polyurethane: it's self-extinguishing, and CFC/HCFC-free, with ODP=0 (Ozone Depletion Potential), meaning it does not contribute to depletion of the ozone layer. Internal structure in PP made from 100% recycled material, external casing in polypropylene (PP).

ARMRESTS

Available in fixed or 1D adjustable: in height; 3D adjustable: height, rotation and seat slide; or 4D adjustable: height, width, rotation and forward slide of the TPU soft touch top. Also available with armrest featuring 360° adjustment and TPU soft touch top pad.

MECHANISMS

Three different types of mechanism available: Synchron 4 locking positions with or without seat slider and synchron 5 locking positions with seat slider and tilt adjustment.

GAS COLUMN

Steel gas lift column for adjusting seat height.

BASE

5-star pyramid base in nylon (PA) with special reinforcement ribs, diameter 690 mm, or in polished aluminium diameter 690 mm.

CASTORS

Free castors 55 mm diameter and self-braking with or without chrome 65 mm diameter. (each type to be used on a specific base).

FABRICS AND MESHES

Available in different types and colours as detailed in the LT Form upholstery charts.

* Su richiesta omologazione 11M in categoria "C" con supplemento 5%

* Available on request with 11M approval in category "C" with 5% surcharge

BRACCIOLI / ARMRESTS

F03

Braccioli fissi in PP neri
 Fixed armrests in black PP

R01

Braccioli regolabili 1D
 -In plastica regolabile in altezza
 1D adjustable armrests
 -In plastic, height adjustable

R10

Braccioli regolabili 3D con pad in PU
 -In plastica regolabile in altezza
 -Traslazione e rotazione del top in PU
 3D adjustable armrests with PU pad
 -In plastic, height adjustable
 -Slide and rotation of the PU top

R04

Braccioli regolabili 4D con staffa in alluminio
 -In plastica e alluminio regolabile in altezza
 -Regolazione in larghezza del top soft touch in TPU
 -Traslazione e rotazione del top soft touch in TPU
 4D adjustable armrests with aluminium bracket
 -In plastic and aluminium, height adjustable
 -Width adjustment of the TPU top pad
 -Slide and rotation of the TPU top pad

R06

Braccioli regolabili con PAD 360°
 -In plastica con pad top soft touch in TPU
 -Regolabile in altezza
 -Regolabili 360°
 Adjustable armrests with 360° PAD
 -In plastic with soft touch TPU pad
 -Height adjustable
 -360° adjustable

MECCANISMI / MECHANISMS

S04

Synchron 4 blocchi
 - 4 posizione di blocco
 -Inclinazione schienale sedile
 -Regolazione intensità oscillazione
 -Regolazione altezza sedile
 Synchron 4 locking positions
 -4 locking positions
 -Seat backrest tilt
 -Oscillation intensity adjustment
 -Seat height adjustment

S05

Synchron 4 blocchi con traslatore
 - 4 posizione di blocco
 -Inclinazione schienale sedile
 -Regolazione intensità oscillazione
 -Regolazione altezza sedile
 -Traslazione del sedile in avanti
 Synchron 4 lock with seat slider
 - 4 locking positions
 -Seat backrest tilt
 -Oscillation level adjustment
 -Seat height adjustment
 -Forward sliding seat

S06

Synchron 5 blocchi con traslatore
 -5 posizione di blocco
 -Inclinazione schienale sedile
 -Regolazione intensità oscillazione autopesante
 -Regolazione altezza sedile
 -Traslazione del sedile in avanti
 Synchron 5 lock with seat slider
 -5 locking positions
 -Seat backrest tilt
 -Weight-sensitive tilt intensity adjustment
 -Seat height adjustment
 -Forward sliding seat

BASI / BASES

B23

Base 5 razze piramidale Ø690 nylon nero
 5-star pyramid base Ø690 black Nylon

B25

Base 5 razze Ø690 alluminio
 5-star base Ø690 in aluminium

RUOTE / CASTORS

R06

Ruote stop gommatae Ø65
 -autofrenante Ø65
 Rubber stop castors Ø65
 -self-braking Ø65

R09

Ruote stop gommatae Ø65 cromate
 -autofrenante Ø65
 Chromed Ø65 rubber stop castors
 -self-braking Ø65

R10

Ruote dure nylon Ø55
 -libera Ø55
 Hard nylon castors Ø55
 -free Ø55



DIMENSIONI / SIZE

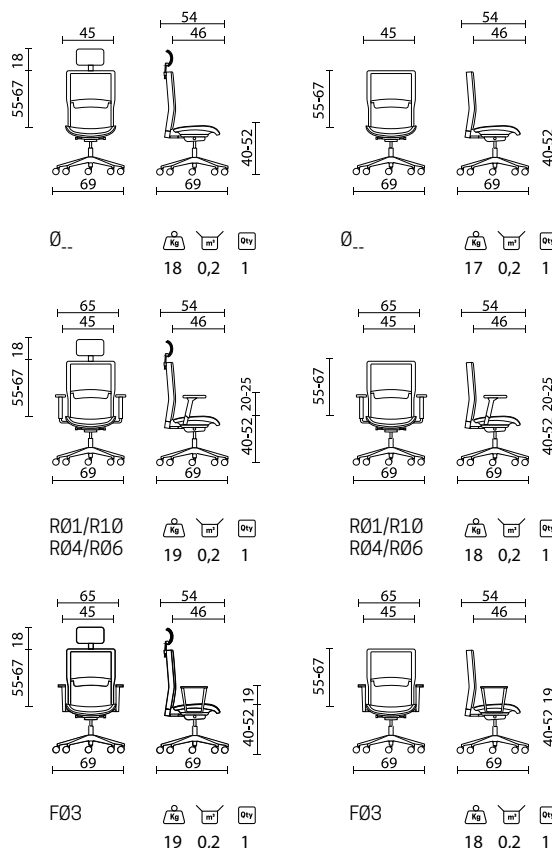

CERTIFICAZIONI / CERTIFICATIONS

SEDIA OPERATIVA

POGGIATESTA

Allo schienale è applicabile un poggiatesta in nylon regolabile in altezza con imbottitura in poliuretano espanso stampato a freddo.

SCHIENALE

Telaio portante in nylon con cornice di supporto rete in polipropilene. Schienale regolabile in altezza tramite sistema up/down e supporto lombare regolabile in altezza, lama portante in nylon.

SEDILE

Costituito da un telaio portante in Nylon caricato fibra di vetro combinato con un pannello traforato in polipropilene dotato di texture elastica traspirante, rivestita a sua volta da una rete a scelta tra quelle proposte nella cartella rivestimenti LT Form.

BRACCIOLI

Disponibile nella tipologia fisso o regolabili 1D: in altezza, 3D altezza, rotazione e traslazione o regolabili 4D: altezza, larghezza, rotazione e traslazione in avanti del top soft touch TPU. Disponibile inoltre bracciolo con regolazione 360° e top soft touch in TPU.

MECCANISMI

Disponibili tre diverse tipologie di meccanismo:
Synchron 4 blocchi con o senza traslatore e synchron 5 blocchi con traslatore e variatore d'assetto.

COLONNA A GAS

Colonna a gas in acciaio che permette la regolazione in altezza del sedile.

BASE

Tipologia a cinque razze piramidale in nylon (PA) con apposite nervature di rinforzo, diametro 690 mm o in alluminio lucido diametro 690 mm.

RUOTE

Libere da diametro 55 mm e autofrenanti cromate e non diametro 65 mm. (ognuna dedicata alla base adatta).

TESSUTI E RETI

Disponibili in diverse tipologie e colorazioni presenti nelle cartelle rivestimenti LT Form.

OPERATIVE CHAIR

HEADREST

Backrest can be fitted with a height-adjustable nylon headrest with cold-moulded polyurethane foam upholstery.

BACKREST

Supporting frame in nylon with mesh support frame in polypropylene. Height-adjustable backrest with up/down system and height-adjustable lumbar support, nylon back bar.

SEAT

Consisting of a load-bearing frame in glass-fibre nylon combined with a perforated polypropylene panel featuring a breathable elastic texture, which is then covered with a mesh selected from those available in the LT Form upholstery chart.

ARMRESTS

Available in fixed or 1D adjustable: in height; 3D adjustable: height, rotation and seat slide; or 4D adjustable: height, width, rotation and forward slide of the TPU soft touch top. Also available with armrest featuring 360° adjustment and TPU soft touch top pad.

MECHANISMS

Three different types of mechanism available:
Synchron 4 locking positions with or without seat slider and synchron 5 locking positions with seat slider and tilt adjustment.

GAS COLUMN

Steel gas lift column for adjusting seat height.

BASE

5-star pyramid base in nylon (PA) with special reinforcement ribs, diameter 690 mm, or in polished aluminium diameter 690 mm.

CASTORS

Free castors 55 mm diameter and self-braking with or without chrome 65 mm diameter. (each type to be used on a specific base).

FABRICS AND MESHES

Available in different types and colours as detailed in the LT Form upholstery charts.

BRACCIOLI / ARMRESTS



F03

Braccioli fissi in PP neri
 Fixed armrests in black PP



R01

Braccioli regolabili 1D
 -In plastica regolabile in altezza
 1D adjustable armrests
 -In plastic, height adjustable



R10

Braccioli regolabili 3D con pad in PU
 -In plastica regolabile in altezza
 -Traslazione e rotazione del top in PU
 3D adjustable armrests with PU pad
 -In plastic, height adjustable
 -Slide and rotation of the PU top



R04

Braccioli regolabili 4D con staffa in alluminio
 -In plastica e alluminio regolabile in altezza
 -Regolazione in larghezza del top soft touch in TPU
 -Traslazione e rotazione del top soft touch in TPU
 4D adjustable armrests with aluminium bracket
 -In plastic and aluminium, height adjustable
 -Width adjustment of the TPU top pad
 -Slide and rotation of the TPU top pad



R06

Braccioli regolabili con PAD 360°
 -In plastica con pad top soft touch in TPU
 -Regolabile in altezza
 -Regolabili 360°
 Adjustable armrests with 360° PAD
 -In plastic with soft touch TPU pad
 -Height adjustable
 -360° adjustable

MECCANISMI / MECHANISMS



S04

Synchron 4 blocchi
 - 4 posizione di blocco
 -Inclinazione schienale sedile
 -Regolazione intensità oscillazione
 -Regolazione altezza sedile
 Synchron 4 locking positions
 -4 locking positions
 -Seat backrest tilt
 -Oscillation intensity adjustment
 -Seat height adjustment



S05

Synchron 4 blocchi con traslatore
 - 4 posizione di blocco
 -Inclinazione schienale sedile
 -Regolazione intensità oscillazione
 -Regolazione altezza sedile
 -Traslazione del sedile in avanti
 Synchron 4 lock with seat slider
 - 4 locking positions
 -Seat backrest tilt
 -Oscillation level adjustment
 -Seat height adjustment
 -Forward sliding seat



S06

Synchron 5 blocchi con traslatore
 -5 posizione di blocco
 -Inclinazione schienale sedile
 -Regolazione intensità oscillazione autopesante
 -Regolazione altezza sedile
 -Traslazione del sedile in avanti
 Synchron 5 lock with seat slider
 -5 locking positions
 -Seat backrest tilt
 -Weight-sensitive tilt intensity adjustment
 -Seat height adjustment
 -Forward sliding seat

BASI / BASES



B23

Base 5 razze piramidale Ø690 nylon nero
 5-star pyramid base Ø690 black Nylon



B25

Base 5 razze Ø690 alluminio
 5-star base Ø690 in aluminium

RUOTE / CASTORS



R06

Ruote stop gommatae Ø65
 -autofrenante Ø65
 Rubber stop castors Ø65
 -self-braking Ø65



R09

Ruote stop gommatae Ø65 cromate
 -autofrenante Ø65
 Chromed Ø65 rubber stop castors
 -self-braking Ø65



R10

Ruote dure nylon Ø55
 -libera Ø55
 Hard nylon castors Ø55
 -free Ø55



DIMENSIONI / SIZE

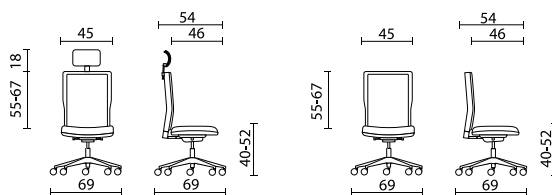

0_ 17 0,2 1

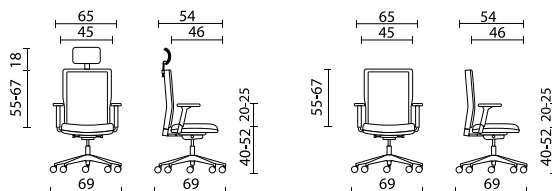

R01/R10 18 0,2 1
R04/R06

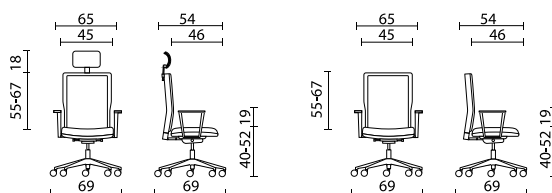

F03 18 0,2 1

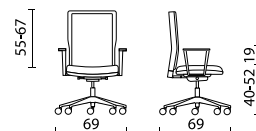

F03 17 0,2 1

CERTIFICAZIONI / CERTIFICATIONS



SEDIA OPERATIVA

POGGIATESTA

Allo schienale è applicabile un poggiatesta in nylon regolabile in altezza con imbottitura in poliuretano espanso stampato a freddo.

SCHIENALE

Telaio portante in nylon con cornice di supporto rete in polipropilene. Schienale regolabile in altezza tramite sistema up/down e supporto lombare regolabile in altezza, lama portante in nylon.

SEDILE

Imbottito con poliuretano "flessibile" stampato a freddo, autoestinguento, privo di CFC/HCFC, con ODP=0 (Ozone Depletion Potential), non contribuisce alla riduzione dello strato di ozono atmosferico. Struttura interna in materiale plastico PP da materiale riciclato 100%, carter esterno in materiale plastico polipropilene (PP).

BRACCIOLI

Disponibile nella tipologia fisso o regolabili 1D: in altezza, 3D altezza, rotazione e traslazione o regolabili 4D: altezza, larghezza, rotazione e traslazione in avanti del top soft touch TPU. Disponibile inoltre bracciolo con regolazione 360° e top soft touch in TPU.

MECCANISMI

Disponibili tre diverse tipologie di meccanismo: Synchron 4 blocchi con o senza traslatore e synchron 5 blocchi con traslatore e variatore d'assetto.

COLONNA A GAS

Colonna a gas in acciaio che permette la regolazione in altezza del sedile.

BASE

Tipologia a cinque razze piramidale in nylon (PA) con apposite nervature di rinforzo, diametro 690 mm o in alluminio lucido diametro 690 mm.

RUOTE

Libere da diametro 55 mm e autofrenanti cromate e non diametro 65 mm. (ognuna dedicata alla base adatta).

TESSUTI E RETI

Disponibili in diverse tipologie e colorazioni presenti nelle cartelle rivestimenti LT Form.

OPERATIVE CHAIR

HEADREST

Backrest can be fitted with a height-adjustable nylon headrest with cold-moulded polyurethane foam upholstery.

BACKREST

Supporting frame in nylon with mesh support frame in polypropylene. Height-adjustable backrest with up/down system and height-adjustable lumbar support, nylon back bar.

SEAT

Upholstered with "flexible" cold-moulded polyurethane: it's self-extinguishing, and CFC/HCFC-free, with ODP=0 (Ozone Depletion Potential), meaning it does not contribute to depletion of the ozone layer. Internal structure in PP made from 100% recycled material, external casing in polypropylene (PP).

ARMRESTS

Available in fixed or 1D adjustable: in height; 3D adjustable: height, rotation and seat slide; or 4D adjustable: height, width, rotation and forward slide of the TPU soft touch top. Also available with armrest featuring 360° adjustment and TPU soft touch top pad.

MECHANISMS

Three different types of mechanism available: Synchron 4 locking positions with or without seat slider and synchron 5 locking positions with seat slider and tilt adjustment.

GAS COLUMN

Steel gas lift column for adjusting seat height.

BASE

5-star pyramid base in nylon (PA) with special reinforcement ribs, diameter 690 mm, or in polished aluminium diameter 690 mm.

CASTORS

Free castors 55 mm diameter and self-braking with or without chrome 65 mm diameter. (each type to be used on a specific base).

FABRICS AND MESHES

Available in different types and colours as detailed in the LT Form upholstery charts.

* Su richiesta omologazione 11M in categoria "C" con supplemento 5%

* Available on request with 11M approval in category "C" with 5% surcharge

BRACCIOLI / ARMRESTS



F03

Braccioli fissi in PP neri
 Fixed armrests in black PP



R01

Braccioli regolabili 1D
 -In plastica regolabile in altezza
 1D adjustable armrests
 -In plastic, height adjustable



R10

Braccioli regolabili 3D con pad in PU
 -In plastica regolabile in altezza
 -Traslazione e rotazione del top in PU
 3D adjustable armrests with PU pad
 -In plastic, height adjustable
 -Slide and rotation of the PU top



R04

Braccioli regolabili 4D con staffa in alluminio
 -In plastica e alluminio regolabile in altezza
 -Regolazione in larghezza del top soft touch in TPU
 -Traslazione e rotazione del top soft touch in TPU
 4D adjustable armrests with aluminium bracket
 -In plastic and aluminium, height adjustable
 -Width adjustment of the TPU top pad
 -Slide and rotation of the TPU top pad



R06

Braccioli regolabili con PAD 360°
 -In plastica con pad top soft touch in TPU
 -Regolabile in altezza
 -Regolabili 360°
 Adjustable armrests with 360° PAD
 -In plastic with soft touch TPU pad
 -Height adjustable
 -360° adjustable

MECCANISMI / MECHANISMS



S04

Synchron 4 blocchi
 - 4 posizione di blocco
 -Inclinazione schienale sedile
 -Regolazione intensità oscillazione
 -Regolazione altezza sedile
 Synchron 4 locking positions
 -4 locking positions
 -Seat backrest tilt
 -Oscillation intensity adjustment
 -Seat height adjustment



S05

Synchron 4 blocchi con traslatore
 - 4 posizione di blocco
 -Inclinazione schienale sedile
 -Regolazione intensità oscillazione
 -Regolazione altezza sedile
 -Traslazione del sedile in avanti
 Synchron 4 lock with seat slider
 - 4 locking positions
 -Seat backrest tilt
 -Oscillation level adjustment
 -Seat height adjustment
 -Forward sliding seat



S06

Synchron 5 blocchi con traslatore
 -5 posizione di blocco
 -Inclinazione schienale sedile
 -Regolazione intensità oscillazione autopesante
 -Regolazione altezza sedile
 -Traslazione del sedile in avanti
 Synchron 5 lock with seat slider
 -5 locking positions
 -Seat backrest tilt
 -Weight-sensitive tilt intensity adjustment
 -Seat height adjustment
 -Forward sliding seat

BASI / BASES



B23

Base 5 razze piramidale Ø690 nylon nero
 5-star pyramid base Ø690 black Nylon



B25

Base 5 razze Ø690 alluminio
 5-star base Ø690 in aluminium

RUOTE / CASTORS



R06

Ruote stop gommatae Ø65
 -autofrenante Ø65
 Rubber stop castors Ø65
 -self-braking Ø65



R09

Ruote stop gommatae Ø65 cromate
 -autofrenante Ø65
 Chromed Ø65 rubber stop castors
 -self-braking Ø65



R10

Ruote dure nylon Ø55
 -libera Ø55
 Hard nylon castors Ø55
 -free Ø55